

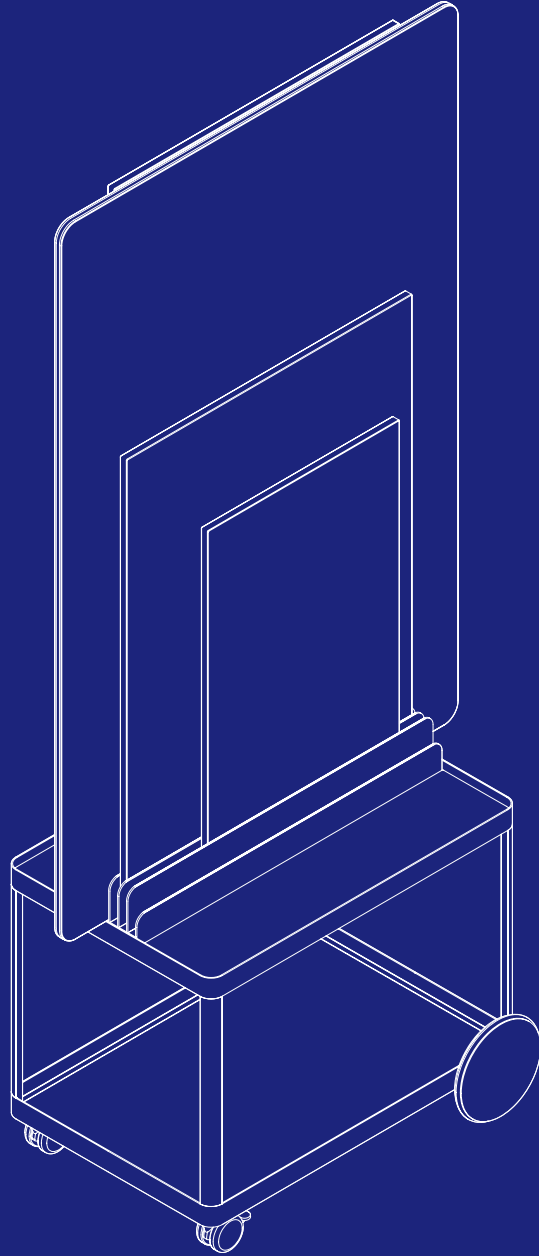

MOCON

THE MODULAR BOARD SYSTEM

WORKBOOK



CONTENTS

| | |
|--------------------------------------|-------|
| Agile work methods..... | 5 |
| Studio Besau-Marguerre | 6 |
| The modular board system..... | 8 |
| | |
| The Mocon collection | 10 |
| Mocon – Mobile Stand..... | 12 |
| Mocon – Desk Stand..... | 13 |
| Mocon – Wall Rail..... | 14 |
| Mocon – Whiteboards..... | 15 |
| Mocon – Acoustic Boards..... | 16 |
| Mocon – Acrylic Glass Boards..... | 17 |
| Mocon – Accessories..... | 18-19 |
| | |
| Mocon in the office..... | 23 |
| Mocon in meeting rooms..... | 24 |
| Mocon in workshops..... | 25 |
| Mocon – individual workspaces | 26 |
| Mocon – spaces for focused work..... | 27 |
| Mocon in open team spaces..... | 28 |
| Mocon for presentations | 29 |
| | |
| Delivery times..... | 31 |

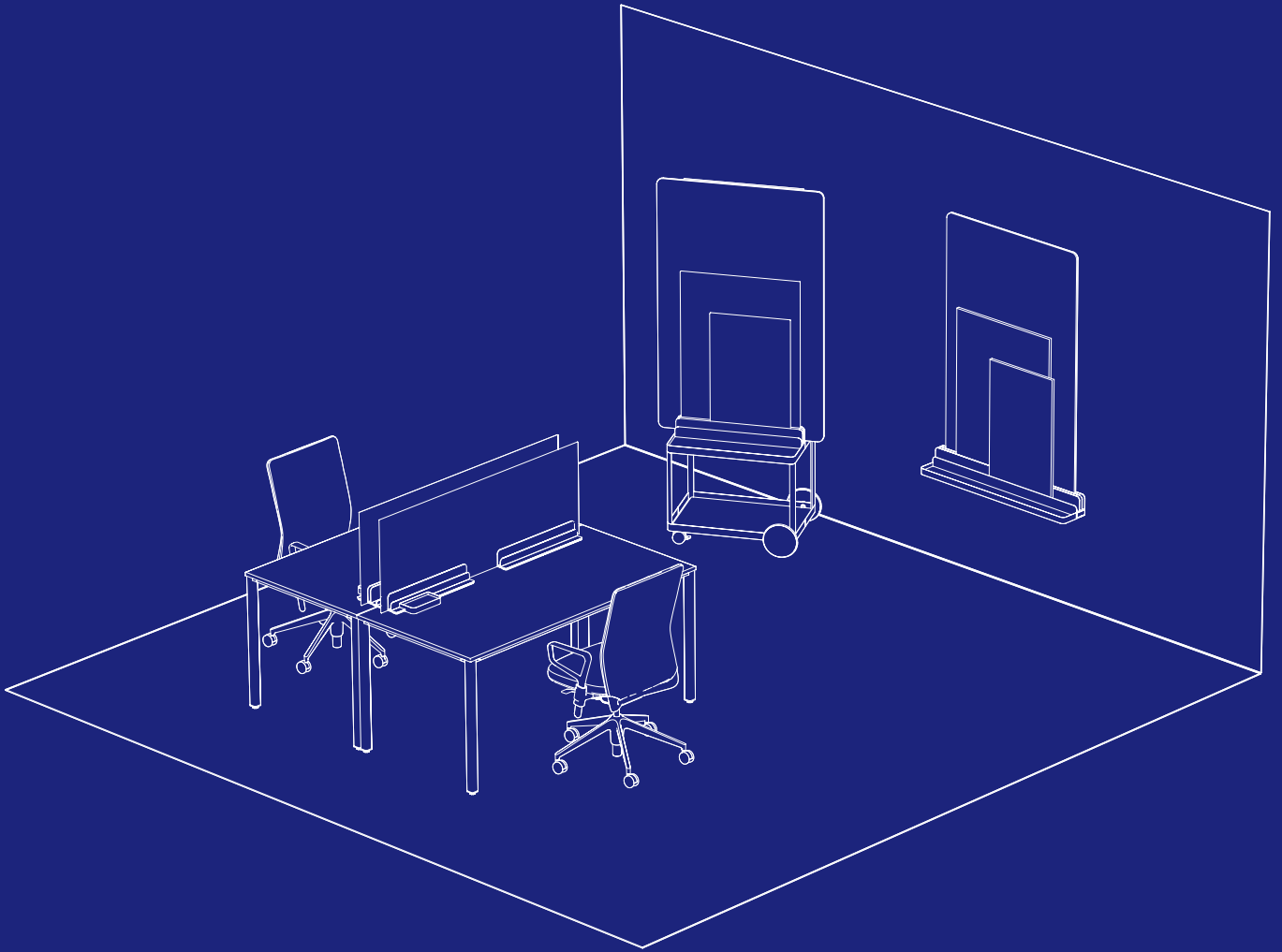

Agile work environments

The office and the ways in which work is organised are in a state of flux. Agility drives forward the restructuring of many processes both within individual teams and entire companies as part of the New Work mindset. And at the heart of these changes are people and the challenges of new kinds of work environments.

At the same time, agility means breaking up rigid structures, giving work processes more flexibility and making space for creativity. Managers have to respond proactively to changes in the world of work, in order to offer their staff the opportunity to make the most of their potential through agile processes.

The office of the future needs to be reinterpreted due to the changing processes and this new mindset. Companies have to enable their employees to deal with new, complex tasks in open-plan offices, in their own workspace where they can focus, or working together as part of a team.

As an expert in contemporary workspace design, SIGEL provides solutions that allow agile work environments – where the focus is on flexibility, agility and mobility – to be more than just an abstract concept. Instead, they can be something that the team experiences and shapes together.



STUDIO BESAU-MARGUERRE

This creative designer duo lives and loves the changes brought by New Work. From their own experience, they understand both the opportunities and the challenges of the agile working world, and have developed fitting product ideas in partnership with SIGEL. The result is Mocon, a modular board system, which also has a central place in the Besau-Marguerre designer studio. Marcel Besau describes the modular board system as a “mobile work-in-progress element” that is intended to encourage collaborative work on ideas. Presentations and concepts are often prepared, shared with others and then further developed in collaboration. Mocon is predestined for this kind of flexible mindset.

The two creative designers always devise new products with a holistic approach to solutions at their back of their mind. Their ideas go far beyond the rigid boundaries of typical everyday office life. The Besau-Marguerre approach goes perfectly with SIGEL’s concept of new work environments, uniting aspects such as sustainability, agility, comfort and value. A striking look and this special choice of materials are the designer duo’s signature style. The clear design language is instantly recognisable and makes each individual item a highlight in any office. Due to the addition of practical elements in great colours and high-quality materials, the office of today becomes a “home from home” in which an atmosphere of well-being allows the ideas to flow.

besau-marguerre.de



Marcel Besau and Eva Marguerre

Eva Marguerre and Marcel Besau founded the Besau-Marguerre design studio in 2011 in the heart of Hamburg. They have been nominated for several international design competitions and have won numerous awards. In addition to this, for many years their products have been exhibited at renowned trade fairs in Germany and around the world.

Mocon, the modular board system

Mocon has a timeless elegance, is of top quality and multifunctional: mobile, to write on, doubles as a pinboard, sound-absorbent. Free-standing in the room, on the desk or wall, the board system supports creative people in developing, recording and presenting ideas stylishly.

At the heart of the collection are the various portable boards: they are the blank canvas for creative ideas. The different board versions come without a frame in a choice of formats and can be used as a whiteboard, acoustic board or acrylic glass board for agile project work. The various securing systems for the desk, wall or mobile stand for the room form the basis of the Mocon modular board system. Each securing element comes with dividers for inserting the boards. Work with the boards is intuitive: sketching, writing lists of ideas or highlighting a particular concept.

A very important part of New Work is a sense of well-being and feeling valued while working. Familiar materials and a choice of fresh colours help to create an atmosphere of well-being in everyday office life.



The Mocon collection

It is not only Mocon's innovative design that is bound to impress. With its numerous, easy-to-combine functions it is ideally adapted to the demands of New Work.

Bases

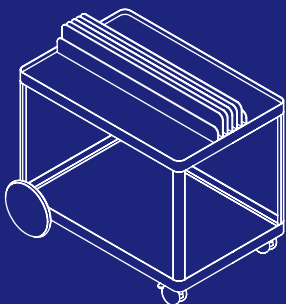

Mobile Stand

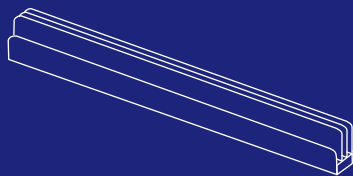

Wall Rail

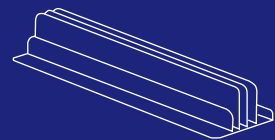

Desk Stand

What makes Mocon special:

- Can be integrated into any room set-up or location
- For use on the table, around the room or on the wall
- Unique due to its innovative design
- Modular, versatile options for use
- Wide choice of different boards
(whiteboards, acrylic glass boards, acoustic boards) in various sizes

Boards



Whiteboard



Acoustic Board

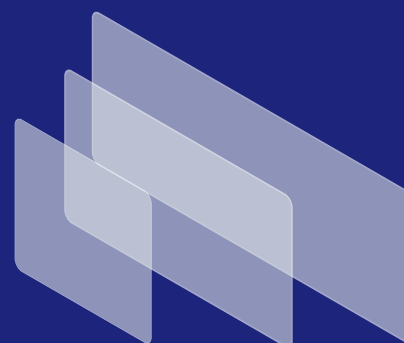

Acrylic Glass Board

“The core of the modular board system is the agile, multi-layered connection of the various work and room set-ups to the ways in which people work.”

Besau-Marguerre

Mocon – Mobile Stand

The mobile stand is a portable presentation cart that transports the various boards while serving as a work tool and presentation surface at the same time.





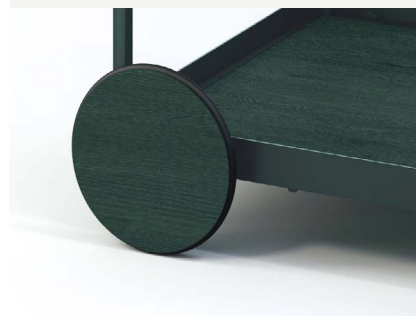
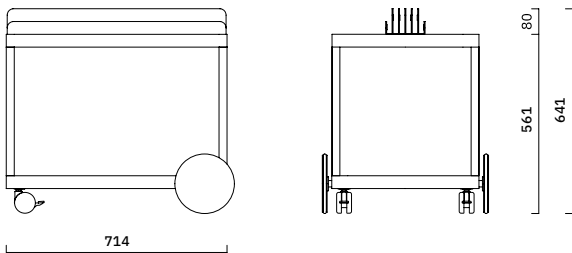
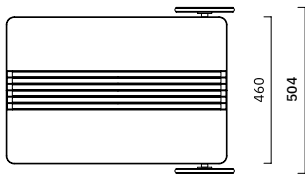

Thanks to the innovative layering principle, several boards can be secured at the same time and used as required.

| Product | Prod. code | WxHxD | Weight |
|--------------|-------------|----------------|---------|
| Mobile Stand | MO300-MO305 | 714x641x504 mm | 28.9 kg |

Dimensioning



Material and colour

| | | |
|--|--|--|
|  Powder-coated graphite black RAL 9011  Real wood veneer Black |  Powder-coated cobalt blue RAL 5013  Real wood veneer Cobalt blue |  Powder-coated black green RAL 6012  Real wood veneer Green |
|  Powder-coated ultramarine blue RAL 5002  Real wood veneer Ultramarine blue |  Powder-coated sulphur yellow RAL 1016  Real wood veneer Sulphur yellow |  Powder-coated traffic white RAL 9016  Real wood veneer White |

Model

- 6 dividers
- For whiteboards S-XL, acoustic boards M-XL
- Small castors: plastic
- Shelves and large wheels: multiplex board with real wood veneer, varnished
- Dividers: aluminium and steel, powder-coated



Model

- 3 dividers
- For whiteboards S, Panorama acoustic boards S-L, Panorama acrylic glass boards S-L
- Repositionable, lockable clamp for mounting on a desk
- Dividers: aluminium and steel, powder-coated
- Clamp: steel

Mocon – Desk Stand

Take the results of a meeting or brainstorming session straight back to your desk. Simply insert the board into the desk stand and all the information is on hand. At the same time, the system functions as a room divider and, in combination with acoustic boards, as a sound-proof screen between two workspaces.

| Product | Prod. code | WxHxD | Weight |
|------------|-------------|---------------|--------|
| Desk Stand | M0400-M0405 | 550x89x142 mm | 3.8 kg |

Dimensioning

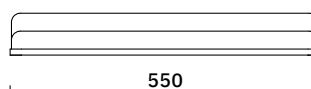
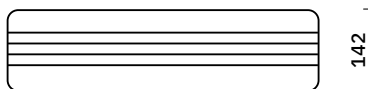

Material and colour



Powder-coated
graphite black
RAL 9011



Powder-coated
cobalt blue
RAL 5013



Powder-coated
black green
RAL 6012



Powder-coated
ultramarine blue
RAL 5002



Powder-coated
sulphur yellow
RAL 1016



Powder-coated
traffic white
RAL 9016

Mocon – Wall Rail

The wall rail is the easy way to place whiteboards or acoustic boards in different formats on the wall. And it is just as easy to take them down and use them elsewhere. Make a bold statement by placing important information at the front or lining up boards in a row.

| Product | Prod. code | WxHxD | Weight |
|-----------|-------------|---------------|--------|
| Wall Rail | MO200-MO205 | 1000x92x77 mm | 8.2 kg |

Dimensioning

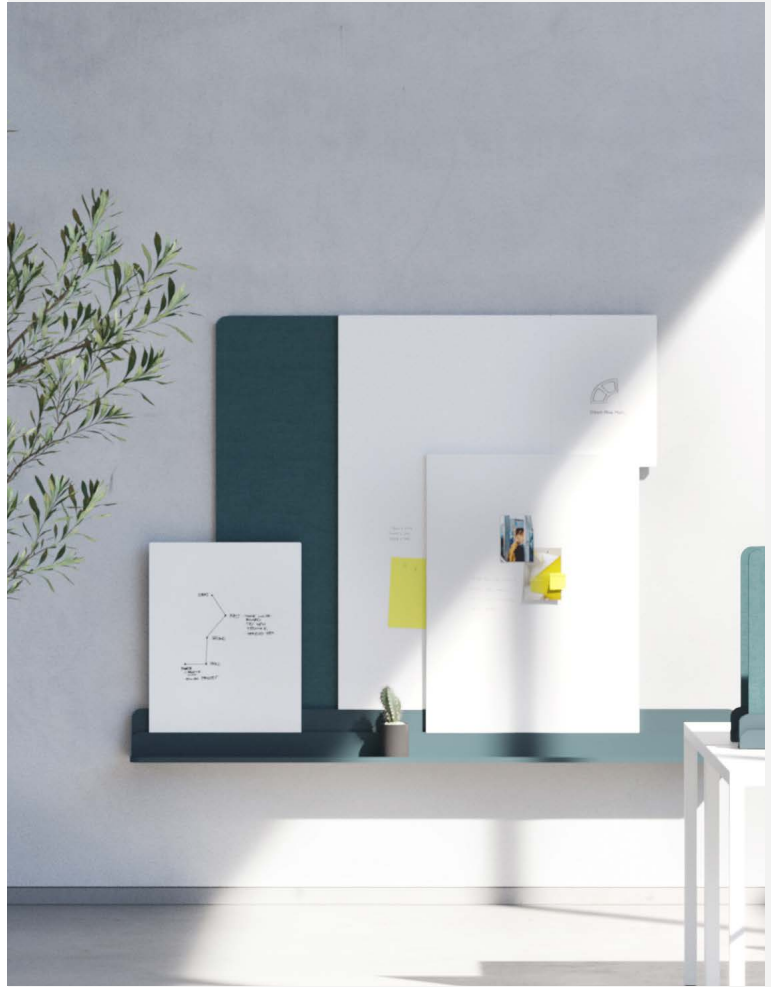
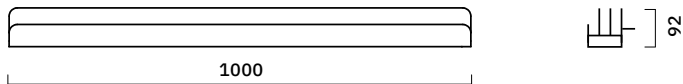
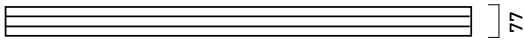

Material and colour



Model

- 3 dividers
- For whiteboards S-XL and acoustic boards M-XL
- Wall rail for wall mounting
- Dividers: aluminium, powder-coated



Model

- High-quality melamine surface, magnetic, to write on and wipe clean
- Frameless; border is the same colour as the board
- Both sides of the surface can be used

Mocon – Whiteboards

The mobile whiteboards from the SIGEL range are real eye-catchers in any office thanks to their modern design. They were conceived for use with the mobile stand, desk stand and wall rail, to allow creative work wherever inspiration strikes.

The frameless whiteboards are available in sizes S-XL; both sides can be used. They are magnetic, can be written on and are easy to wipe clean.

| Product | Prod. code | WxHxD | Weight |
|---------------|------------|----------------|--------|
| Whiteboard S | M0011 | 430x680x16 mm | 2 kg |
| Whiteboard M | M0012 | 640x890x16 mm | 3.9 kg |
| Whiteboard L | M0013 | 640x1390x16 mm | 6.1 kg |
| Whiteboard XL | M0014 | 890x1390x16 mm | 8.5 kg |

Dimensioning

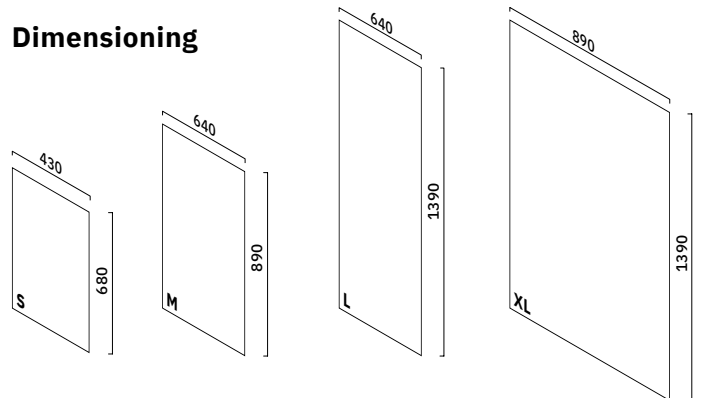

Material and colour



White
RAL 9016

Surface: high pressure laminate (HPL),
glossy
Core: polyurethane foam
Border: plastic

Mocon – Acoustic Boards

The acoustic boards from the SIGEL range serve as a sound absorber for the room, and are also ideal for use as a pinboard to visualise and present ideas. If required, they can be used to divide the room into smaller workspaces in combination with the mobile stand.

| Product | Prod. code | WxHxD | Weight |
|---------------------------|------------|------------------|--------|
| Acoustic board M | MO100-104 | 640x890x15.6 mm | 4.1 kg |
| Acoustic board L | MO110-114 | 640x1390x15.6 mm | 5.8 kg |
| Acoustic board XL | MO120-124 | 890x1390x15.6 mm | 7.4 kg |
| Acoustic board Panorama S | MO130-134 | 600x500x15.6 mm | 2.4 kg |
| Acoustic board Panorama M | MO140-144 | 1000x500x15.6 mm | 3.8 kg |
| Acoustic board Panorama L | MO150-154 | 1400x500x15.6 mm | 5.1 kg |

Dimensioning

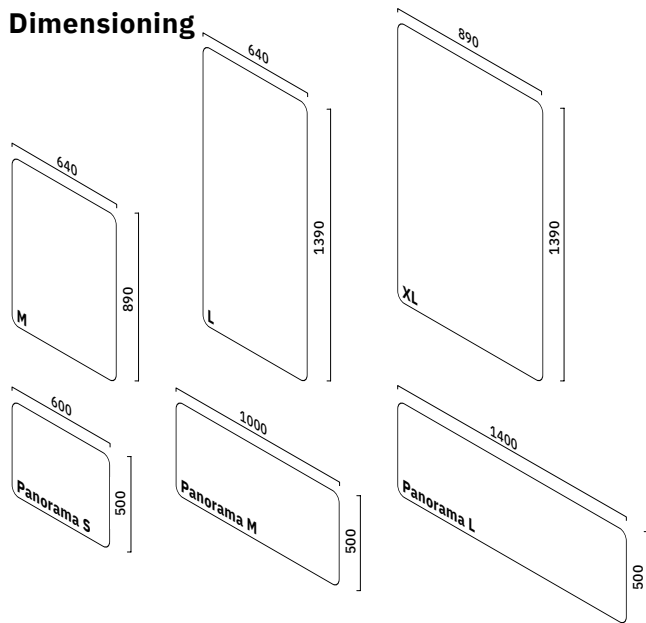

Material and colour

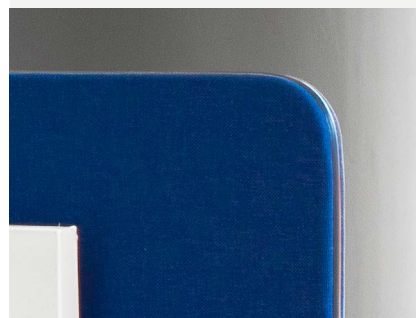
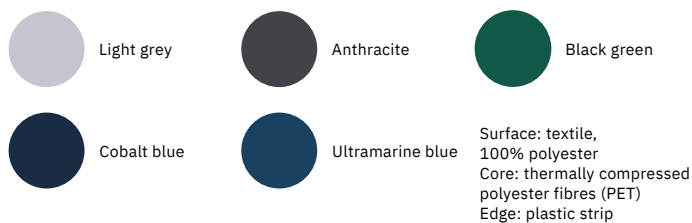

Model

- High-quality fabric surface, doubles as a pinboard
- Certified acoustic efficiency for optimising room acoustics
- With a colour-coordinated strip all around the edge
- Both sides of the board can be used

- For use in the mobile stand and wall rail in formats M-XL
- For use in the desk stand in the panorama formats S-L



Mocon – Acrylic Glass Boards

A high-quality acrylic glass surface meets functionality in the workplace: the acrylic glass boards can be used flexibly on the desk. Both sides can be written on. In combination with the board-securing system and board accessories, they become a highly versatile tool for creative ideas, while doubling as a hygienic screen between desks.

| Product | Prod. code | WxHxD | Weight |
|--------------------------------|------------|---------------|--------|
| Panorama acrylic glass board S | MO030 | 600x500x5 mm | 1.7 kg |
| Panorama acrylic glass board M | MO031 | 1000x500x5 mm | 2.8 kg |
| Panorama acrylic glass board L | MO032 | 1400x500x5 mm | 4 kg |

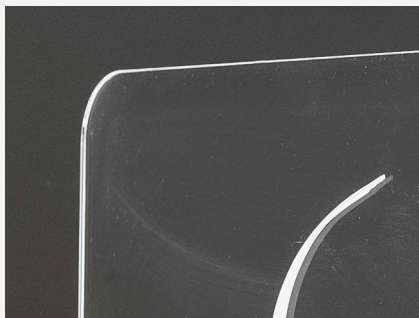

Model

- High-quality acrylic glass surface, to write on and wipe clean
- Without a frame; with polished, deburred edges
- Both sides of the board can be used
- A flexible adapter holds the board securely in the desk stand

Dimensioning

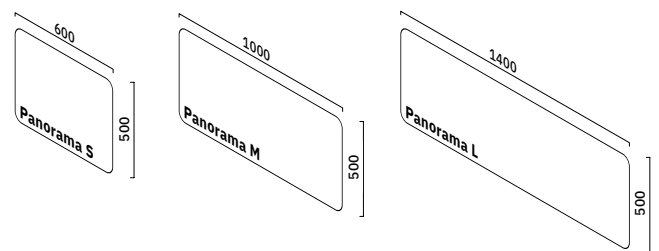

Material and colour



Material: acrylic glass

Mocon – Accessories

Board markers

These marker pens are the perfect board accessory, available in a choice of colours for all whiteboards, magnetic glass boards, acrylic boards and flipcharts.

| Product | Prod. code | WxHxD | Contents |
|-----------------------------------|------------|--------------|----------|
| black, blue, green, red | BA010 | 149x83x22 mm | 4 pcs. |
| black, magenta, turquoise, orange | BA011 | 149x83x22 mm | 4 pcs. |
| black | BA012 | 149x83x22 mm | 4 pcs. |



Magnets and pins

The magnet set consists of four neodymium magnets, in a pine casing and nickel-plated.

The high-quality pins are manufactured sustainably and have a light coloured, solid wood head.

| Product | Prod. code | WxHxD | Contents |
|------------------------|------------|------------|----------|
| Wooden magnets, round | BA210 | Ø33x9 mm | 4 pcs. |
| Wooden magnets, square | BA211 | 33x33x9 mm | 4 pcs. |
| Wooden pins | BA240 | Ø12x22 mm | 25 pcs. |



Cleaning cloth

The soft microfibre cloth wipes all boards clean of ink and dust, quickly and effortlessly. Thanks to the integrated magnet, it holds securely to whiteboards and magnetic glass boards.

| Product | Prod. code | WxHxD | Contents |
|-------------------------|------------|--------------|----------|
| Magnetic cleaning cloth | BA110 | 250x250x3 mm | 1 pc. |



Wooden board eraser

The magnetic board eraser made of light-coloured pine is the fast way to dry-erase whiteboards and glass boards (incl. spare pad).



| Product | Prod. code | WxHxD | Contents |
|---------------------|------------|--------------|----------|
| Wooden board eraser | BA120 | 130x60x21 mm | 1 pc. |

Board cleaning spray

The board cleaning spray (250 ml) removes ink residue, dust and dirt from standard whiteboards and glass boards, quickly and streak-free. The liquid is biodegradable.



| Product | Prod. code | WxHxD | Contents |
|----------------------|------------|--------------|----------|
| Board cleaning spray | BA140 | 50x198x50 mm | 1 pc. |

Starter sets for whiteboards, magnetic glass boards and pinboards

The perfect starter set for all SIGEL boards

The starter set contains: board markers, wooden magnets, a wooden board eraser incl. washable spare pad, a washable cleaning cloth (magnetic), a board cleaning spray and wooden pins. The board accessories are supplied in a box with practical inner compartments and a magnetic fastener for a tidy workspace.

| Product | Prod. code | WxHxD | Contents |
|--|------------|---------------|----------|
| Starter set for whiteboards, magnetic boards & pinboards | BA310 | 360x76x230 mm | 1 set |



Starter sets for whiteboards/magnetic glass boards

The board accessories for the SIGEL whiteboards and magnetic glass boards. With board markers, wooden magnets, a wooden board eraser incl. washable spare pad, cleaning cloth and board cleaning spray.

| Product | Prod. code | WxHxD | Contents |
|--|------------|---------------|----------|
| Starter set for whiteboards, magnetic glass boards | BA311 | 360x76x230 mm | 1 set |







Meeting
12:00

– More
than just a
workplace



Mocon in the office

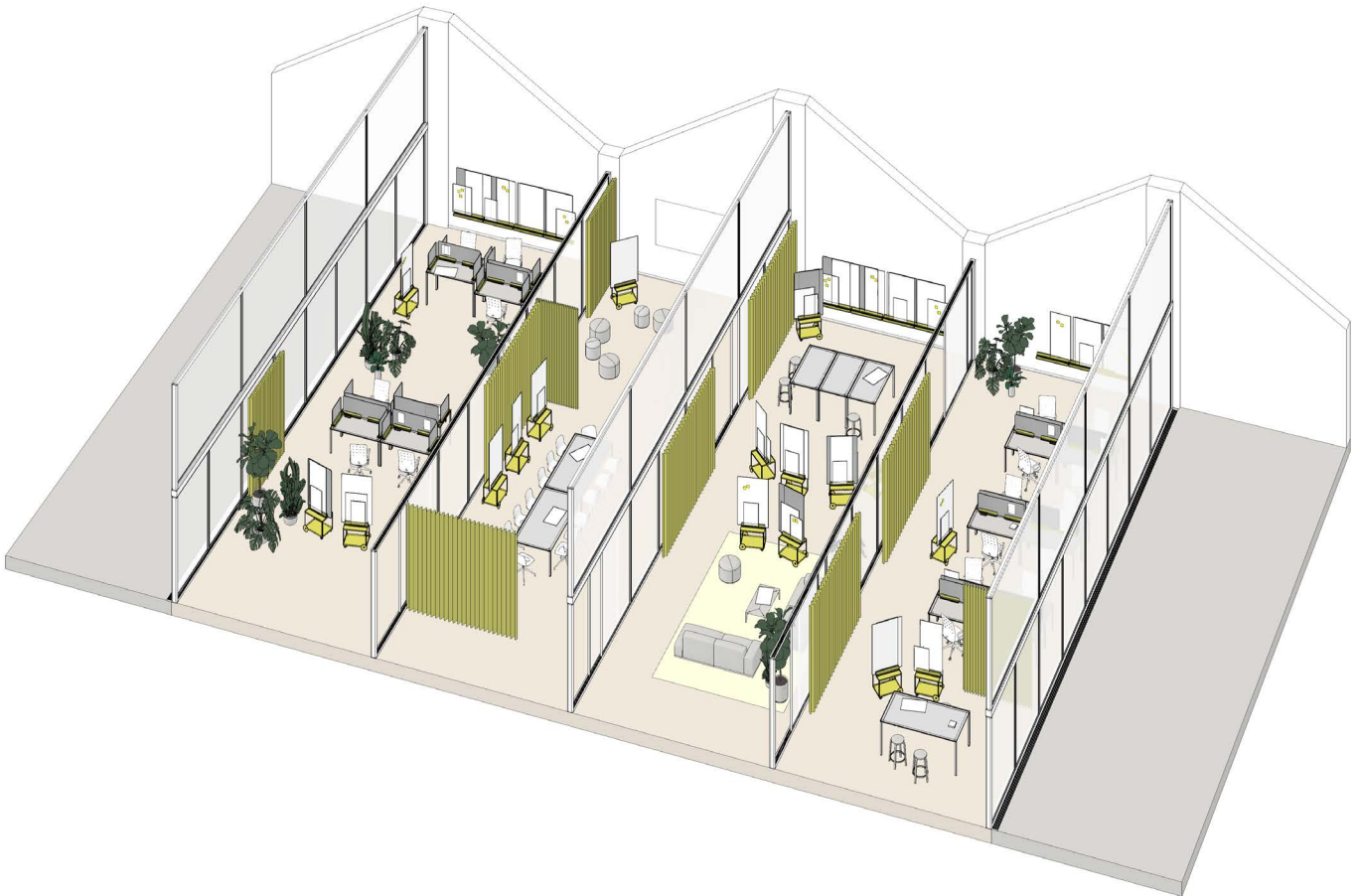

Solutions for agile work environments

Mocon supports the changes that New Work brings. Above all, companies that value an agile working day and flexible work processes and solutions will profit from its many applications.

With Mocon, SIGEL provides mobile solutions and tools for open-plan offices, meeting rooms or workshop areas. The Mocon modules are used intuitively and spontaneously, both for innovative thought processes and the creation of new work environments. Different elements can be combined with each other in order to form workspaces tailored to individual requirements. This supports individual working methods, spontaneity and flexibility.

Applications include:

- Offices and home offices
- Implementation of agile methods
- Meetings
- Workshops
- Workplace design
- Open team spaces
- Conferences

Mocon – meeting rooms

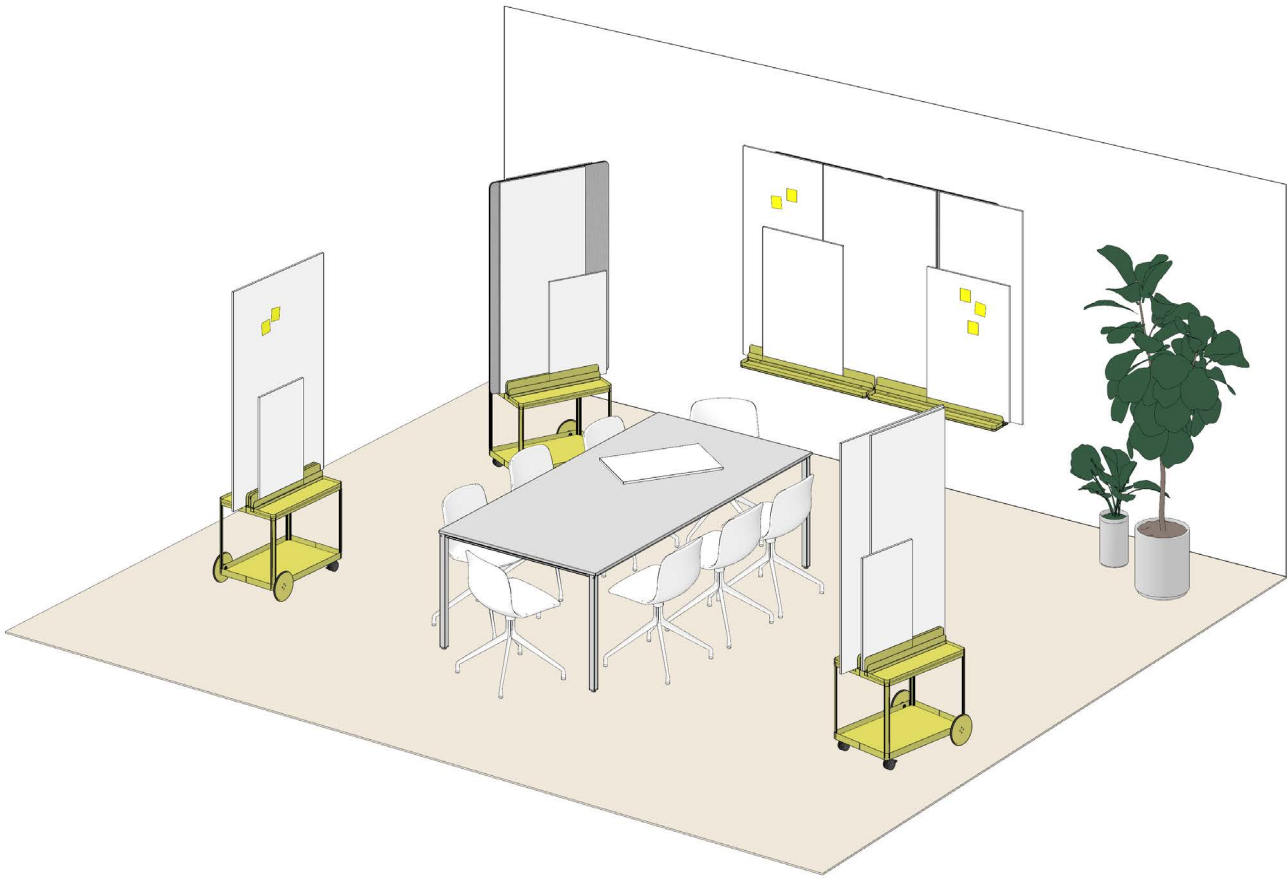

Mocon in meeting rooms

The professional exchange of ideas is generally the top priority in any meeting room, where the mobile Mocon elements encourage agile work. The various board-securing systems and boards are ideal for presentations. They support an active exchange of ideas and collaborative project work.

Suggested products



Mobile Stand

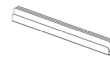

Wall Rail



Acoustic board XL



Whiteboard XL



Whiteboard L



Whiteboard M



Whiteboard S

Mocon – workshops



Mocon in workshops

One room, a whole range of ideas: mobile Mocon elements help to make work more collaborative and dynamic during workshops. By making flexible use of the space, people are able to work freely. This allows ideas to flow in different locations and positions.

Mobile Mocon elements can also be used as screens and for sound insulation. Particularly in office workshop situations, they are quick and easy to adapt to new room set-ups, tasks and conditions.

Suggested products



Mobile Stand

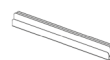

Wall Rail



Acoustic board XL



Whiteboard XL



Whiteboard L



Whiteboard M



Whiteboard S

Mocon – individual workspaces

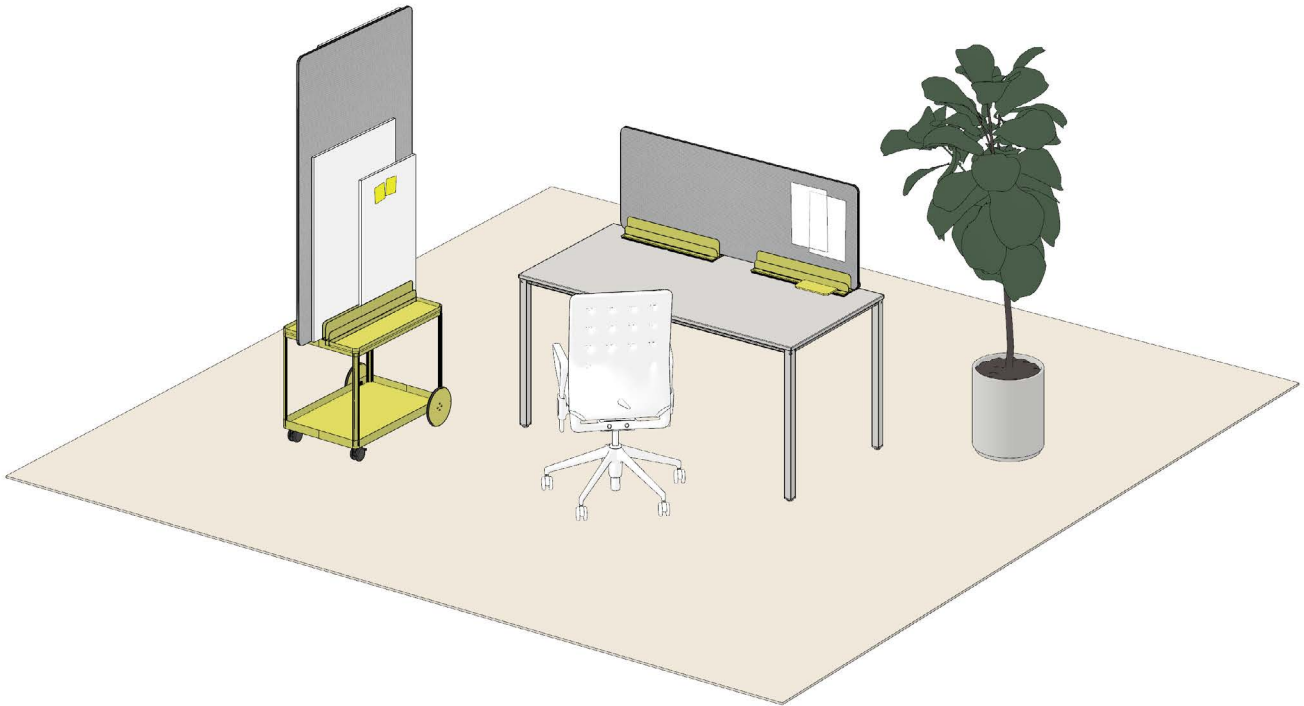

Mocon in individual workspaces

When your head is full of exciting ideas: various Mocon elements are also ideal for use in individual workspaces. They encourage concentration while working and allow the results of creative brainstorming sessions to be noted down straight away.

Thanks to the combination of different colours, materials and formats, it is easy to create a bespoke workspace for flexible work.

Suggested products



Mobile Stand



Desk Stand



Acoustic board XL



Whiteboard M



Whiteboard S



Acoustic board
Panorama L

Mocon – spaces for focused work

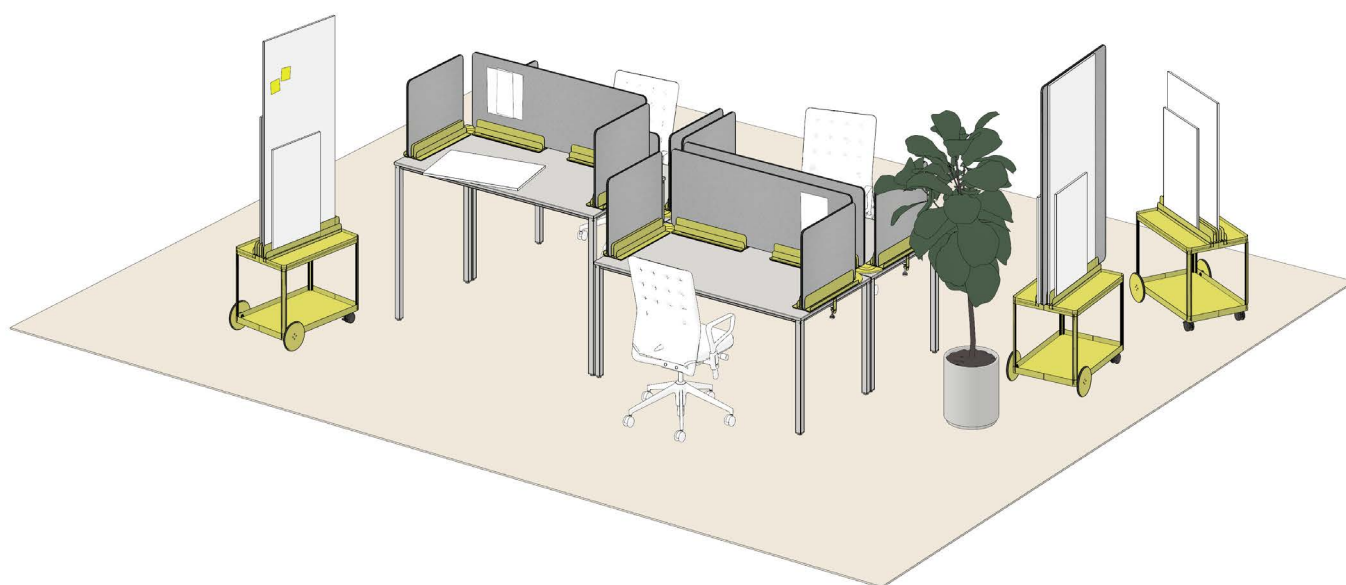

Mocon for open office workstations

Together but still able to focus: Mocon in open office workstations promotes concentration while making it easy to talk to colleagues. The result is greater efficiency for many of the company's work processes.

The desk stands combined with various Mocon boards ensure that each workspace is a separate unit and provides space for generating ideas. Acoustic boards significantly reduce the noise level.

From hygienic screens to impromptu brainstorming, the boards have a wide range of uses in open office workstations.

Suggested products



Mobile Stand



Desk Stand



Acoustic board XL



Whiteboard L



Acoustic board
Panorama L



Acoustic board
Panorama S



Whiteboard M



Whiteboard S

Mocon for open team spaces



Mocon for open team spaces

The highly versatile mobile Mocon elements can be positioned wherever required around an open team space. Each person is able to work however suits them best. Some team members can work on a project without disturbing their colleagues at their desks. Thanks to flexible zoning, it is easier to work simultaneously and effectively in the same room.

Suggested products



Mobile Stand

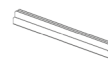

Wall Rail



Acoustic board XL



Whiteboard XL



Whiteboard L



Whiteboard M



Whiteboard S



Desk Stand



Acoustic board
Panorama L

Mocon for presentations

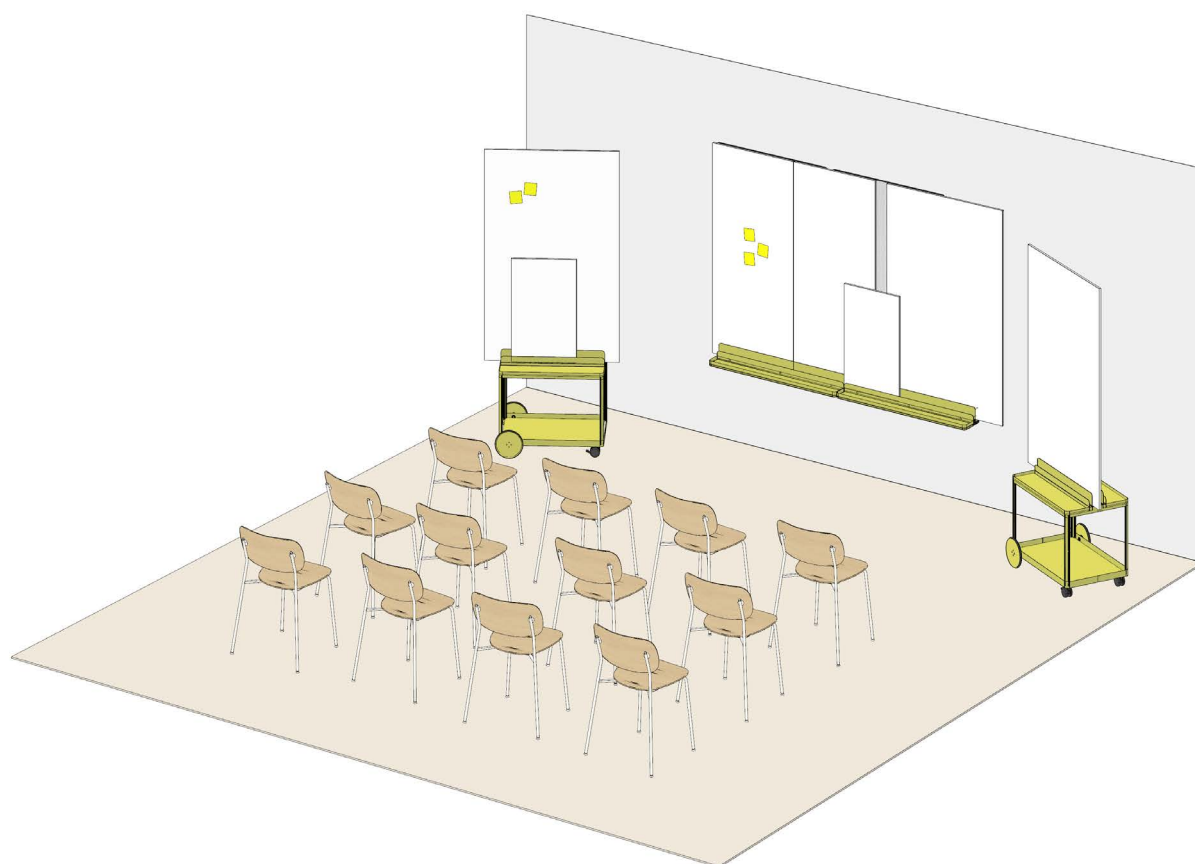

Mocon for presentations

It is easy to create large-scale presentation areas with different Mocon elements. In particular, the large boards provide plenty of space for information and creative ideas.

Suggested products



Mobile Stand

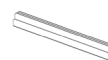

Wall Rail



Acoustic board L



Whiteboard XL



Whiteboard L



Whiteboard M



Whiteboard S



General information

Our prices

All prices are listed excluding VAT. We reserve the right to change the prices of our products. In some rare cases, there may be changes to the construction and design of our products.

Customer complaints

All SIGEL products meet extremely high standards of quality. Despite regular inspections, minor defects cannot be completely ruled out.

Please check the delivered goods immediately upon receipt for possible damage. Any obvious damage to the goods should be entered on the forwarding agent's delivery note, so that a claim can be made at a later date. You can, of course, also report any further damage that can only be seen after unpacking, assembling or closer inspection of the product.

Please report defects in writing, including pictures if possible, your order number and complete name, to enable us to address your concern as quickly as possible.

Our guarantee

The legal warrantee applies to your order starting from the day of delivery. If you experience any problems with your new product, please do not hesitate to contact us.

Our terms and conditions apply.

For more information, visit www.sigel-office.com

Subject to changes and modifications. Illustrations are not to scale.



SIGEL GmbH

Bäumenheimer Str. 10
86690 Mertingen
Germany

Phone +49 90 78 81- 0
officesolutions@sigel.de

sigel-office.com

